

BSW-PG-Tr-Rd



BSW PG Tr Rd

Qualità certificata... ma non solo dal Certificatore
Certified quality... but not only by the certifier
Qualité certifiée...

QUALITY



MASCHI A MANO

HAND TAPS - TARAUDS MAIN

-DIN
352

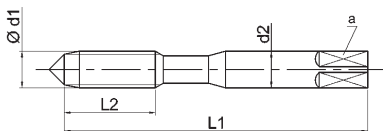

-DIN
352

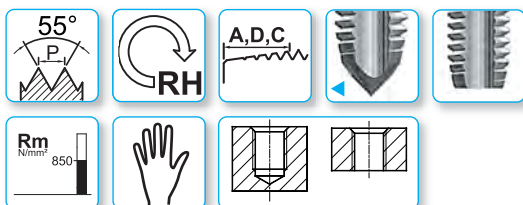
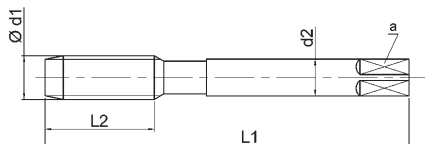

LINE



A
5-6

LINE



D
4-5

LINE



C
2-3

LINE



Profond. di filettatura - Thread depth - Profond. de filetage

Materiale - Material - Matériau

Tolleranza - Tolerance - Tolérance

Trattamento superficiale - Surface treatment - Revêtement

Numero gruppi materiali

Material's groups number

Nombre de groupes du matériau

2xD	2xD	2xD	2xD
HSS	HSS	HSS	HSS
-	-	med.	med.
BR	BR	BR	BR
1.1 1.2 1.3 1.4	1.1 1.2 1.3 1.4	1.1 1.2 1.3 1.4	1.1 1.2 1.3 1.4
2.1 2.2 2.3 3.1 3.4	2.1 2.2 2.3 3.1 3.4	2.1 2.2 2.3 3.1 3.4	2.1 2.2 2.3 3.1 3.4
4.1 4.2 4.3 4.4	4.1 4.2 4.3 4.4	4.1 4.2 4.3 4.4	4.1 4.2 4.3 4.4
5.1 5.2 5.3	5.1 5.2 5.3	5.1 5.2 5.3	5.1 5.2 5.3

-DIN 352	$\varnothing d1$ BSW	P TPI	\varnothing mm	L_1	L_2	d_2 h9	a h12	Z	
	1/8	40	3,175	40	9	3,5	2,7	3	2,5
	3/16	24	4,762	50	13	6	4,9	3	3,6
	1/4	20	6,350	56	15	6	4,9	3	5
	5/16	18	7,938	63	19	6	4,9	3	6,5
	3/8	16	9,525	70	22	7	5,5	3	7,9
	7/16	14	11,113	70	22	8	6,2	3	9,2
	1/2	12	12,700	75	28	9	7	3	10,5
	9/16	12	14,288	80	30	11	9	4	12
	5/8	11	15,876	80	30	12	9	4	13,4
	3/4	10	19,051	95	34	14	11	4	16,4
	7/8	9	22,226	100	34	18	14,5	4	19,25
	1"	8	25,401	110	38	18	14,5	4	22
	1 1/8"	7	28,576	125	45	22	18	4	24,75
	1 1/4"	7	31,751	125	45	22	18	4	27,5
	1 1/2"	6	38,101	150	55	28	22	4	33,5

CODICE - CODE

01W...	02W...	03W...	00W...
<input type="radio"/>	<input type="radio"/>	<input type="radio"/>	<input type="radio"/>
<input type="radio"/>	<input type="radio"/>	<input type="radio"/>	<input type="radio"/>
<input type="radio"/>	<input type="radio"/>	<input type="radio"/>	<input type="radio"/>
<input type="radio"/>	<input type="radio"/>	<input type="radio"/>	<input type="radio"/>
<input type="radio"/>	<input type="radio"/>	<input type="radio"/>	<input type="radio"/>
<input type="radio"/>	<input type="radio"/>	<input type="radio"/>	<input type="radio"/>
<input type="radio"/>	<input type="radio"/>	<input type="radio"/>	<input type="radio"/>
<input type="radio"/>	<input type="radio"/>	<input type="radio"/>	<input type="radio"/>
<input type="radio"/>	<input type="radio"/>	<input type="radio"/>	<input type="radio"/>
<input type="radio"/>	<input type="radio"/>	<input type="radio"/>	<input type="radio"/>
<input type="radio"/>	<input type="radio"/>	<input type="radio"/>	<input type="radio"/>
<input type="radio"/>	<input type="radio"/>	<input type="radio"/>	<input type="radio"/>
<input type="radio"/>	<input type="radio"/>	<input type="radio"/>	<input type="radio"/>
<input type="radio"/>	<input type="radio"/>	<input type="radio"/>	<input type="radio"/>

Confezione: Singola
Box: Single
Colis: Unique

€ Pag. listino - Price list - Liste des prix

100

100

100

100

• Standard

○ Disponibilità da richiedere, prezzo a listino
On enquiry, standard price-list / Stock à vérifier

★ Solo a richiesta
Only on request / Sur demande

N **USO GENERALE**
General purpose - Usage Général

MASCHI A MACCHINA
MACHINE TAPS - TARAUDS MACHINE

DIN 371

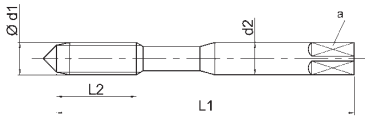

DIN 376

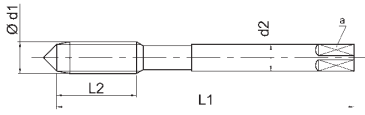

DIN 376

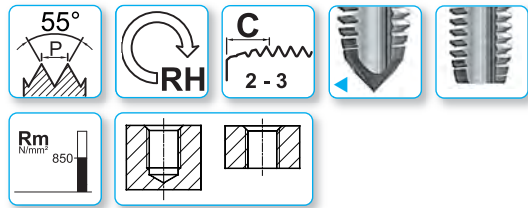
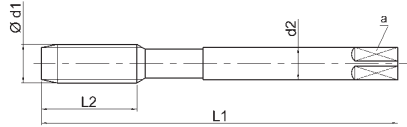

Profond. di filettatura - Thread depth - Profond. de filetage

Materiale - Material - Matériau

Tolleranza - Tolerance - Tolérance

Trattamento superficiale - Surface treatment - Revêtement

Numero gruppi materiali
Material's groups number
Nombre de groupes du matériau

1,5xD **1,5xD**

HSSE **HSSE**

med. **med.**

BR **TiN**

1.1 1.2 1.3 1.4 3.4 1.1 1.2 1.3 1.4 3.4

4.2 4.3 5.2 5.3 4.2 4.3 5.2 5.3

8.2 8.2

DIN 371	Ød1 BSW	P TPI	Ø mm	L ₁	L ₂	d ₂ h9	a h12	Z	
◀	1/8	40	3,175	56	10	3,5	2,7	3	2,5
◀	3/16	24	4,762	70	13	6	4,9	3	3,6
◀	1/4	20	6,350	80	16	7	5,5	3	5
◀	5/16	18	7,938	90	18	8	6,2	3	6,5
◀	3/8	16	9,525	100	20	10	8	3	7,9

CODICE - CODE	
E20W...	E20W...T
○	○
○	○
○	○
○	○
○	○

DIN 376	Ød1 BSW	P TPI	Ø mm	L ₁	L ₂	d ₂ h9	a h12	Z	
◀	5/16	18	7,938	90	18	6	4,9	3	6,5
◀	3/8	16	9,525	100	20	7	5,5	3	7,9
	7/16	14	11,113	100	20	8	6,2	3	9,2
	1/2	12	12,700	110	25	9	7	3	10,5
	9/16	12	14,288	110	28	11	9	3	12
	5/8	11	15,876	110	28	12	9	3	13,4
	3/4	10	19,051	125	32	14	11	4	16,4
	7/8	9	22,226	140	32	18	14,5	4	19,25
	1"	8	25,401	160	36	18	14,5	4	22
	1" 1/8	7	28,576	180	46	22	18	4	24,75
	1" 1/4	7	31,751	180	46	22	18	4	27,5
	1" 3/8	6	34,926	200	50	28	22	4	30,5
	1" 1/2	6	38,101	200	50	28	22	4	33,5

CODICE - CODE	
E21W...	E21W...T
○	○
○	○
○	○
○	○
○	○
○	○
○	○
○	○
○	○
○	○
○	○
○	○
○	○
○	○
○	○

Confezione / Box / Colis: 1/8 – 7/16: 10 pezzi / pcs; 1/2 – 5/8: 5 pezzi / pcs; >5/8: singoli / single pcs

€ Pag. listino - Price list - Liste des prix **101** **101**

• Standard ○ Disponibilità da richiedere, prezzo a listino / On enquiry, standard price-list / Stock à vérifier ★ Solo a richiesta / Only on request / Sur demande

N

USO GENERALE

General purpose - Usage Général

MASCHI A MACCHINA

MACHINE TAPS - TARAUDS MACHINE

DIN 371

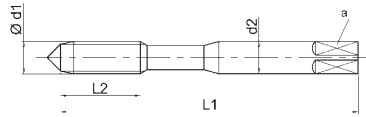

DIN 376

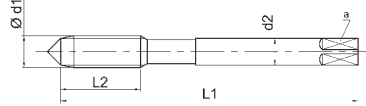

DIN 376

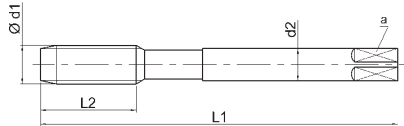

LINE



LINE



LINE



LINE



Profond. di filettatura - Thread depth - Profond. de filetage

Materiale - Material - Matériau

Tolleranza - Tolerance - Tolérance

Trattamento superficiale - Surface treatment - Revêtement

Numero gruppi materiali

Material's groups number

Nombre de groupes du matériau

3xD

HSSE

med.

BR

1.1 1.2 1.3 1.4

4.1 4.2

5.1 5.2

3xD

HSSE

med.

V

1.1 1.2 1.3 1.4

4.1 4.2

5.1 5.2

3xD

HSSE

med.

TiN

1.1 1.2 1.3 1.4

3.3 3.4

4.1 4.2 4.3

3xD

HSSE

med.

XP

1.1 1.2 1.3 1.4

2.1 2.2 3.3 3.4

4.2 4.3

5.2

DIN 371	Ød1 BSW	P TPI	Ø mm	L ₁	L ₂	d ₂ h9	a h12	Z	
◀	1/8	40	3,175	56	10	3,5	2,7	3	2,5
◀	3/16	24	4,762	70	13	6	4,9	3	3,6
◀	1/4	20	6,350	80	16	7	5,5	3	5
◀	5/16	18	7,938	90	18	8	6,2	3	6,5
◀	3/8	16	9,525	100	20	10	8	3	7,9

DIN 376	Ød1 BSW	P TPI	Ø mm	L ₁	L ₂	d ₂ h9	a h12	Z	
◀	5/16	18	7,938	90	18	6	4,9	3	6,5
◀	3/8	16	9,525	100	20	7	5,5	3	7,9
	7/16	14	11,113	100	20	8	6,2	3	9,2
	1/2	12	12,700	110	25	9	7	3	10,5
	9/16	12	14,288	110	28	11	9	3	12
	5/8	11	15,876	110	28	12	9	3	13,4
	3/4	10	19,051	125	32	14	11	4	16,4
	7/8	9	22,226	140	32	18	14,5	4	19,25
	1"	8	25,401	160	36	18	14,5	4	22
	1"1/8	7	28,576	180	46	22	18	4	24,75
	1"1/4	7	31,751	180	46	22	18	4	27,5
	1"3/8	6	34,926	200	50	28	22	4	30,5
	1"1/2	6	38,101	200	50	28	22	4	33,5

E24W...	CODICE - CODE			E24W...XP
	E24W...V	E24W...T		
○	○	○	○	
○	○	○	○	
○	○	○	○	
○	○	○	○	
○	○	○	○	

E25W...	CODICE - CODE			E25W...XP
	E25W...V	E25W...T		
○	○	○	○	
○	○	○	○	
○	○	○	○	
○	○	○	○	
○	○	○	○	
○	○	○	○	
○	○	○	○	
○	○	○	○	
○	○	○	○	
○	○	○	○	
○	○	○	○	
○	○	○	○	
○	○	○	○	
○	○	○	○	
○	○	○	○	

Confezione / Box / Collis:
1/8 – 7/16: 10 pezzi / pcs
1/2 – 5/8: 5 pezzi / pcs
>5/8: singoli / single pcs

€ Pag. listino - Price list - Liste des prix
● Standard

101
○ Disponibilità da richiedere, prezzo a listino
On enquiry, standard price-list / Stock à vérifier

101
★ Solo a richiesta
Only on request / Sur demande

102

N **USO GENERALE**
General purpose - Usage Général

MASCHI A MACCHINA
MACHINE TAPS - TARAUDS MACHINE

DIN 371

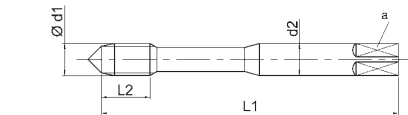

DIN 371

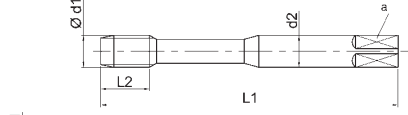

DIN 376

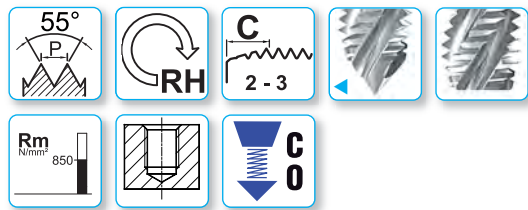
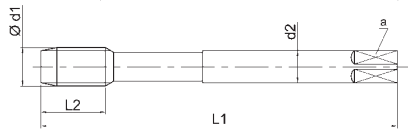

LINE



R40°

LINE



R40°

LINE



R40°

LINE



R40°

Profond. di filettatura - Thread depth - Profond. de filetage

Materiale - Material - Matériau

Tolleranza - Tolerance - Tolérance

Trattamento superficiale - Surface treatment - Revêtement

2,5xD	2,5xD	2,5xD	2,5xD
HSSE	HSSE	HSSE	HSSE
med.	med.	med.	med.
BR	V	TiN	XP
1.1 1.2 1.3 1.4	1.1 1.2 1.3 1.4	1.1 1.2 1.3 1.4	1.1 1.2 1.3 1.4
4.1 4.2	4.1 4.2	3.3 3.4	2.1 2.2 3.3 3.4
5.1 5.2	5.1 5.2	4.1 4.2 4.3	4.2 4.3
		5.1 5.2	5.2

Numero gruppi materiali
Material's groups number
Nombre de groupes du matériau

DIN 371	Ød1 BSW	P TPI	Ø mm	L ₁	L ₂	d ₂ h9	a h12	Z	
◀	1/8	40	3,175	56	5	3,5	2,7	3	2,5
◀	3/16	24	4,762	70	8	6	4,9	3	3,6
◀	1/4	20	6,350	80	10	7	5,5	3	5
	5/16	18	7,938	90	13	8	6,2	3	6,5
	3/8	16	9,525	100	15	10	8	3	7,9

CODICE - CODE			
E60W...	E60W...V	E60W...T	E60W...XP
○	○	○	○
○	○	○	○
○	○	○	○
○	○	○	○
○	○	○	○

DIN 376	Ød1 BSW	P TPI	Ø mm	L ₁	L ₂	d ₂ h9	a h12	Z	
	5/16	18	7,938	90	13	6	4,9	3	6,5
	3/8	16	9,525	100	15	7	5,5	3	7,9
	7/16	14	11,113	100	15	8	6,2	3	9,2
	1/2	12	12,700	110	18	9	7	3	10,5
	9/16	12	14,288	110	20	11	9	3	12
	5/8	11	15,876	110	20	12	9	3	13,4
	3/4	10	19,051	125	25	14	11	4	16,4
	7/8	9	22,226	140	25	18	14,5	4	19,25
	1"	8	25,401	160	30	18	14,5	4	22
	1" 1/8	7	28,576	180	35	22	18	4	24,75
	1" 1/4	7	31,751	180	35	22	18	4	27,5
	1" 3/8	6	34,926	200	40	28	22	4	30,5
	1" 1/2	6	38,101	200	40	28	22	4	33,5

CODICE - CODE			
E61W...	E61W...V	E61W...T	E61W...XP
○	○	○	○
○	○	○	○
○	○	○	○
○	○	○	○
○	○	○	○
○	○	○	○
○	○	○	○
○	○	○	○
○	○	○	○
○	○	○	○
○	○	○	○
○	○	○	○
○	○	○	○
○	○	○	○
○	○	○	○

Confezione / Box / Colis: 1/8 – 7/16: 10 pezzi / pcs; 1/2 – 5/8: 5 pezzi / pcs; >5/8: singoli / single pcs

€ Pag. listino - Price list - Liste des prix

102	102	102	102
-----	-----	-----	-----

• Standard ○ Disponibilità da richiedere, prezzo a listino / On enquiry, standard price-list / Stock à vérifier ★ Solo a richiesta / Only on request / Sur demande

BSW

MASCHI A MACCHINA

MACHINE TAPS - TARAUDS MACHINE

DIN 40432

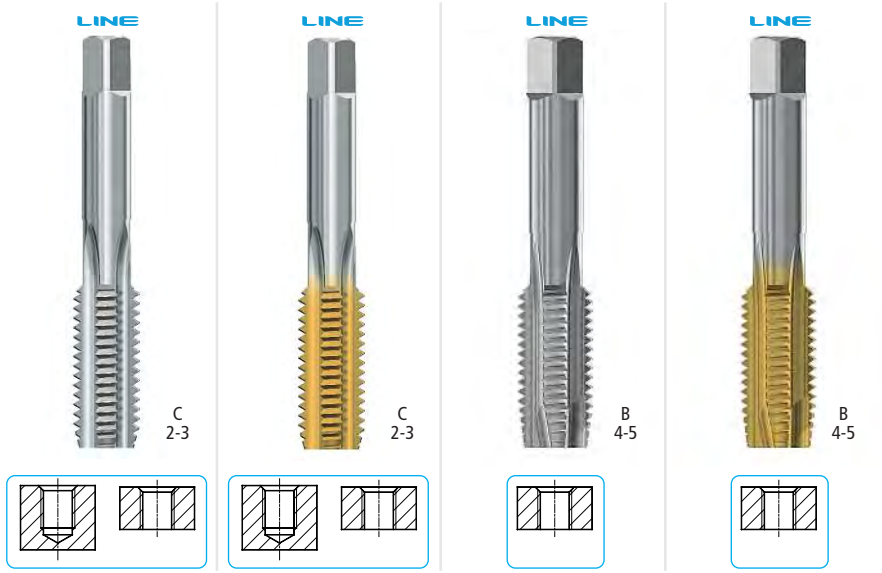
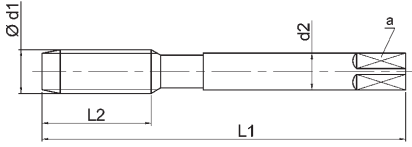

Profond. di filettatura - Thread depth - Profond. de filetage

Materiale - Material - Matériau

Tolleranza - Tolerance - Tolérance

Trattamento superficiale - Surface treatment - Revêtement

Numero gruppi materiali

Material's groups number

Nombre de groupes du matériau

	C 2-3	C 2-3	B 4-5	B 4-5
Profond. di filettatura	1,5xD	1,5xD	3xD	3xD
Materiale	HSSE	HSSE	HSSE	HSSE
Tolleranza	-	-	-	-
Trattamento superficiale	BR	TiN	BR	TiN
Numero gruppi materiali	1.1 1.2 1.3 1.4 3.4 4.2 4.3 5.2 5.3 8.2	1.1 1.2 1.3 1.4 3.4 4.2 4.3 5.2 5.3 8.2	1.1 1.2 1.3 1.4 4.1 4.2 5.1 5.2	1.1 1.2 1.3 1.4 3.3 3.4 4.1 4.2 4.3 5.1 5.2

DIN 40432	Ø mm	P TPI	L ₁	L ₂	d ₂ h9	a h12	Z	Lead
PG 7	12,5	20	70	20	9	7	3	11,4
PG 9	15,20	18	70	20	12	9	4	14
PG 11	18,60	18	80	22	14	11	4	17,25
PG 13,5	20,40	18	80	22	16	12	4	19
PG 16	22,50	18	80	22	18	14,5	4	21,25
PG 21	28,30	16	90	22	22	18	4	27
PG *21	28,30	16	90	22	20	16	4	27
PG 29	37	16	100	25	28	22	6	35,5
PG 36	47	16	140	25	36	29	6	45,5
PG *36	47	16	125	32	36	29	6	45,5
PG 42	54	16	140	28	40	32	6	52,5
PG 48	59,30	16	140	36	45	35	6	58
PG *48	59,30	16	140	32	40	32	6	58

E21PG... CODICE - CODE								
E21PG...		E21PG...T		E25PG...		E25PG...T		
○	○	○	○	○	○	○	○	
○	○	○	○	○	○	○	○	
○	○	○	○	○	○	○	○	
○	○	○	○	○	○	○	○	
○	○	○	○	○	○	○	○	
-	-	-	-	-	-	-	-	
○	○	○	○	○	○	○	○	
○	○	○	○	○	○	○	○	
-	-	-	-	-	-	-	-	
○	○	○	○	○	○	○	○	
○	○	○	○	○	○	○	○	
-	-	-	-	-	-	-	-	

■ = Acciaio HSS / HSS Steel / Acier HSS

* Ad esaurimento, dimensioni secondo la vecchia edizione.
Stock exhausted, dimensions according old edition.
Sous réserve de disponibilité, dimensions selon l'ancienne édition.

Confezione: Singola Box: Single Colis: Unique	€ Pag. listino - Price list - Liste des prix	103	103	103	103
	● Standard	○ Disponibilità da richiedere, prezzo a listino On enquiry, standard price-list / Stock à vérifier		★ Solo a richiesta Only on request / Sur demande	

N **USO GENERALE**
General purpose - Usage Général

MASCHI TRAPEZOIDALI SINGOLI
SINGLE TRAPEZOIDAL TAPS - TARAUDS TRAPÉZOÏDAUX INDIVIDUELS

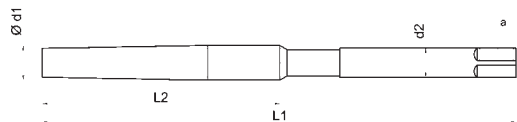

30° P
24 x P
RH LH
Rm
850

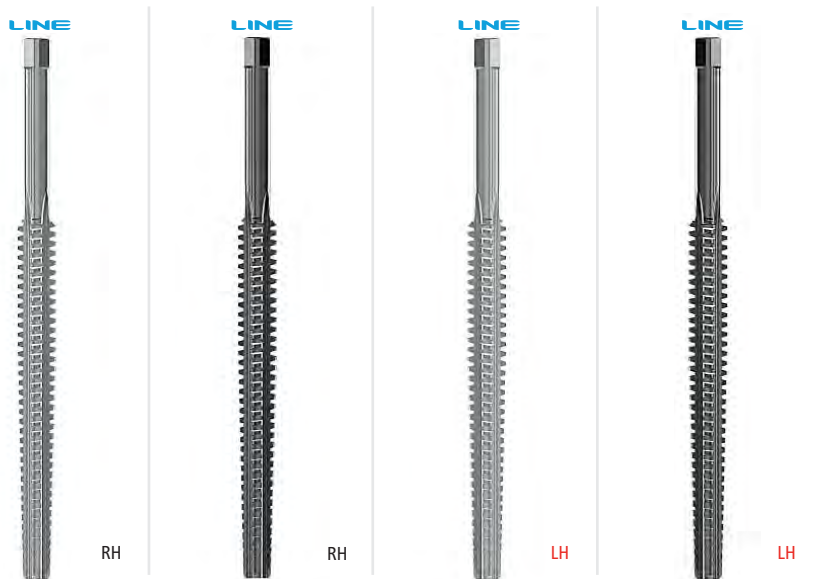

Profond. di filettatura - Thread depth - Profond. de filetage	2xD	2xD	2xD	2xD
Materiale - Material - Matériau	HSSE	HSSE	HSSE	HSSE
Tolleranza - Tolerance - Tolérance	7H	7H	7H	7H
Trattamento superficiale - Surface treatment - Revêtement	BR	V	BR	V
Numero gruppi materiali Material's groups number Nombre de groupes du matériau	1.1 1.2 1.3 1.4 3.1 3.2 3.3 3.4 4.3 4.4 5.3	1.1 1.2 1.3 1.4 3.1 3.2 3.3 3.4 4.1 4.2 4.3 4.4 5.1 5.2 5.3	1.1 1.2 1.3 1.4 3.1 3.2 3.3 3.4 4.3 4.4 5.3	1.1 1.2 1.3 1.4 3.1 3.2 3.3 3.4 4.1 4.2 4.3 4.4 5.1 5.2 5.3

$\varnothing d1$ Tr	P mm	L	L ₁	d ₂ h9	a ₂ h12	Z	Z
10	2	130	70	7	5,5	3	8,2
10	3	155	95	7	5,5	3	7,5
12	2	160	95	8	6,2	3	10,2
12	3	160	95	8	6,2	3	9,25
14	3	170	100	10	8	4	11,25
14	4	210	130	10	8	4	10,5
16	4	225	130	11	9	4	12,25
18	4	225	130	12	9	4	14,25
20	4	230	130	14	11	4	16,25
22	5	270	160	16	12	4	17,25
24	5	280	160	18	14,5	4	19,25
26	5	280	160	20	16	4	21,25
28	5	290	160	22	18	4	23,25
30	6	330	190	22	18	4	24,25
32	6	330	190	25	20	4	26,25
36	6	350	200	28	22	4	30,25

CODICE - CODE			
E21TPN...	E21TPN...V	E21TPN...LH	E21TPN...LH-V
<input type="radio"/>	<input type="radio"/>	<input type="radio"/>	<input type="radio"/>
<input type="radio"/>	<input type="radio"/>	<input type="radio"/>	<input type="radio"/>
<input type="radio"/>	<input type="radio"/>	<input type="radio"/>	<input type="radio"/>
<input type="radio"/>	<input type="radio"/>	<input type="radio"/>	<input type="radio"/>
<input type="radio"/>	<input type="radio"/>	<input type="radio"/>	<input type="radio"/>
<input type="radio"/>	<input type="radio"/>	<input type="radio"/>	<input type="radio"/>
<input type="radio"/>	<input type="radio"/>	<input type="radio"/>	<input type="radio"/>
<input type="radio"/>	<input type="radio"/>	<input type="radio"/>	<input type="radio"/>
<input type="radio"/>	<input type="radio"/>	<input type="radio"/>	<input type="radio"/>
<input type="radio"/>	<input type="radio"/>	<input type="radio"/>	<input type="radio"/>
<input type="radio"/>	<input type="radio"/>	<input type="radio"/>	<input type="radio"/>
<input type="radio"/>	<input type="radio"/>	<input type="radio"/>	<input type="radio"/>
<input type="radio"/>	<input type="radio"/>	<input type="radio"/>	<input type="radio"/>
<input type="radio"/>	<input type="radio"/>	<input type="radio"/>	<input type="radio"/>
<input type="radio"/>	<input type="radio"/>	<input type="radio"/>	<input type="radio"/>
<input type="radio"/>	<input type="radio"/>	<input type="radio"/>	<input type="radio"/>
<input type="radio"/>	<input type="radio"/>	<input type="radio"/>	<input type="radio"/>
<input type="radio"/>	<input type="radio"/>	<input type="radio"/>	<input type="radio"/>
<input type="radio"/>	<input type="radio"/>	<input type="radio"/>	<input type="radio"/>
<input type="radio"/>	<input type="radio"/>	<input type="radio"/>	<input type="radio"/>
<input type="radio"/>	<input type="radio"/>	<input type="radio"/>	<input type="radio"/>

A richiesta / On request / Sur demande:
TR-F

MASCHI A FILETTATURA TONDA

ROUND THREAD TAPS - TARAUD AVEC FILETS RONDS

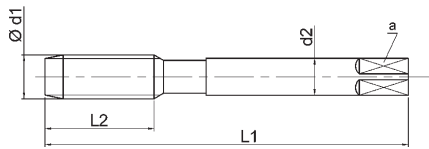

LINE

LINE

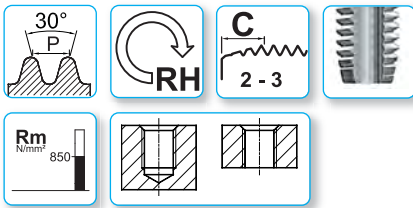

Profond. di filettatura - Thread depth - Profond. de filetage

Materiale - Material - Matériau

Tolleranza - Tolerance - Tolérance

Trattamento superficiale - Surface treatment - Revêtement

Numero gruppi materiali
Material's groups number
Nombre de groupes du matériau

1xD

1xD

HSSE

HSSE

7H

7H

BR

TiN

1.1 1.2 1.3 1.4

1.1 1.2 1.3 1.4

4.1 4.2

3.1 3.2 3.3 3.4

5.1 5.2

4.2 4.3 4.4

5.2 5.3

Ød1 Rd	P TPI	L	L ₁	d ₂ h ₉	a ₂ h ₁₂	Z	
8	10	70	22	8	6,2	3	6
9	10	70	22	8	6,2	3	7
10	10	70	22	8	6,2	3	8
11	10	70	22	8	6,2	3	9
12	10	75	25	9	7	3	10
14	8	80	26	11	9	3	11,5
16	8	80	27	12	9	3	13,5
18	8	95	32	14	11	4	15,5
20	8	95	32	16	12	4	17,5
22	8	100	32	18	14,5	4	19,5
24	8	110	36	18	14,5	4	21,5
26	8	110	36	20	16	4	23,5
28	8	125	34	22	18	4	25,5
30	8	125	34	22	18	4	27,5

Altri diametri disponibili a richiesta.
Other diameters available on request.
Autres diamètres disponibles sur demande.

A richiesta:
Filettatura tonda per il settore minerario DIN 20400
Filettatura tonda per il settore del trasporto su rotaia DIN 264

On request:
Round thread for mining industries DIN 20400
Round thread for rail vehicles DIN 264

Sur demande:
Filetage rond selon DIN 20400

CODICE - CODE
E21RD... E21RD...T

*

*

*

*

*

*

*

*

*

*

*

*

*

*

*

*

*

*

*

*

*

*

*

*

*

*

Confezione: Singola
Box: Single
Colis: Unique

€ Pag. listino - Price list - Liste des prix

104

104

• Standard

○ Disponibilità da richiedere, prezzo a listino
On enquiry, standard price-list / Stock à vérifier

★ Solo a richiesta
Only on request / Sur demande